

KENWOOD

KDC-C512FM

KDC-C462FM

CD AUTOCHANGER / CONTROLLER / FM MODULATOR SYSTEM

INSTRUCTION MANUAL

CONTROLEUR POUR CHANGEUR AUTOMATIQUE DE CD / SYSTEME
A MODULATION DE FREQUENCE

MODE D'EMPLOI

SISTEMA DEL MODULADOR DE FM / CONTROLADOR / CAMBIADOR
AUTOMATICO DE DISCOS COMPACTOS

MANUAL DE INSTRUCCIONES

SISTEMA MODULADOR FM/CONTROLADOR / CHANGER AUTOMÁTICO DE CDs

MANUAL DE INSTRUÇÕES

KENWOOD CORPORATION

**Take the time to read through this instruction manual.
Familiarity with installation and operation procedures will help you
obtain the best performance from your new compact disc auto.changer.**

For your records

Record the serial number, found on the back of the unit, in the spaces designated on the warranty card, and in the space provided below. Refer to the model and serial numbers whenever you call upon your KENWOOD dealer for information or service on the product.

Model KDC-C512FM, KDC-C462FM Serial number _____

©PRINTED IN JAPAN B64-1374-00 (K)
'99/10 9 8 7 6 5 4 3 2 1

COMPACT
disc
DIGITAL AUDIO

Before use

Warning.....	3
Safety precautions	5
Handling compact discs	7
Loading compact discs.....	8

Buttons

Display Unit	9
Remote	9

External disc control features

Playing CDs.....	9
Fast Forwarding and Reversing Disc Play	10
Track search.....	10
Disc search.....	10
Direct Track Search.....	10
Direct Disc Search.....	11
Track repeat	11
Disc repeat.....	11
Track scan	11
Disc scan.....	12
Random play	12
Magazine random play	12
Changing the transmission frequency.....	13
Modulation level/Dynamic control.....	14

Installation

Accessories.....	15
Installation procedure.....	16
Connecting wires to Terminals	16
Installation.....	17

Troubleshooting guide..... 19**Specifications.....** 22



Dear Customer:

Selecting fine audio equipment such as the unit you've just purchased is only the start of your musical enjoyment. Now it's time to consider how you can maximize the fun and excitement your equipment offers. This manufacturer and the Electronic Industries Association's Consumer Electronics Group want you to get the most out of your equipment by playing it at a safe level. One that lets the sound come through loud and clear without annoying blaring or distortion — and, most importantly, without affecting your sensitive hearing.

Sound can be deceiving. Over time your hearing "comfort level" adapts to higher volumes of sound. So what sounds "normal" can actually be loud and harmful to your hearing. Guard against this by setting your equipment at a safe level **BEFORE** your hearing adapts.

To establish a safe level:

- Start your volume control at a low setting.
- Slowly increase the sound until you can hear it comfortably and clearly, and without distortion.

Once you have established a comfortable sound level:

- Set the dial and leave it there.

Taking a minute to do this now will help to prevent hearing damage or loss in the future. After all, we want you listening for a lifetime.



We Want You Listening For A Lifetime

Used wisely, your new sound equipment will provide a lifetime of fun and enjoyment. Since hearing damage from loud noise is often undetectable until it is too late, this manufacturer and the Electronic Industries Association's Consumer Electronics Group recommend you avoid prolonged exposure to excessive noise. This list of sound levels is included for your protection.

Decible Level Example

30	Quiet library, soft whispers
40	Living room, refrigerator, bedroom away from traffic
50	Light traffic, normal conversation, quiet office
60	Air conditioner at 20 feet, sewing machine
70	Vacuum cleaner, hair dryer, noisy restaurant
80	Average city traffic, garbage disposals, alarm clock at two feet.

THE FOLLOWING NOISES CAN BE DANGEROUS UNDER CONSTANT EXPOSURE

90	Subway, motorcycle, truck traffic, lawn mower
100	Garbage truck, chain saw, pneumatic drill
120	Rock band concert in front of speakers, thunderclap
140	Gunshot blast, jet plane
180	Rocket launching pad

Information courtesy of the Deafness Research Foundation.



▲ Warning**▲ CAUTION**

Use of controls or adjustments or performance of procedures other than those specified herein may result in hazardous radiation exposure.

In compliance with Federal Regulations, following are reproductions of labels on, or inside the product relating to laser product safety.

KENWOOD CORPORATION
2967-3, ISHIKAWA-CHO,
HACHIOJI-SHI
TOKYO, JAPAN

KENWOOD CORP. CERTIFIES THIS EQUIPMENT
CONFORMS TO DHHS REGULATIONS NO.21 CFR
1040.10, CHAPTER I, SUBCHAPTER J.

Location : Rear Panel

FCC WARNING

This equipment may generate or use radio frequency energy. Changes or modifications to this equipment may cause harmful interference unless the modifications are expressly approved in the instruction manual. The user could lose the authority to operate this equipment if an unauthorized change or modification is made.

NOTE

This equipment has been tested and found to comply with the limits for a Class B digital device, pursuant to Part 15 of the FCC Rules. These limits are designed to provide reasonable protection against harmful interference in a residential installation. This equipment may cause harmful interference to radio communications, if it is not installed and used in accordance with the instructions. However, there is no guarantee that interference will not occur in a particular installation. If this equipment does cause harmful interference to radio or television reception, which can be determined by turning the equipment off and on, the user is encouraged to try to correct the interference by one or more of the following measures:

- Reorient or relocate the receiving antenna.
- Increase the separation between the equipment and receiver.
- Connect the equipment into an outlet on a circuit different from that to which the receiver is connected.
- Consult the dealer or an experienced radio/TV technician for help.

NOTE

This Class B digital apparatus complies with Canadian ICES-003.

Safety precautions

▲WARNING

Take the following precautions to prevent fire and avoid personal injury:

- When extending the ignition wire, battery wire, or ground wire, use 0.75mm² (AWG18) or larger automotive grade wire to avoid wire deterioration or damage to the covering.
- Check that no metal objects (coins, tools, etc.) are left inside the unit to avoid short circuits.
- If you smell or see smoke, turn the power off immediately and consult your Kenwood dealer.
- Do not touch the liquid crystal fluid if the LCD is damaged or broken due to shock. The liquid crystal fluid may be dangerous to your health or even fatal.
If the liquid crystal fluid from the LCD contacts your body or clothing, wash it off with soap immediately.

▲CAUTION

Take the following precautions to keep the unit in proper working order.

- Be sure the unit is connected to a 12V DC power supply with a negative ground connection.
- Do not open the top or bottom cover.
- Do not install the unit in places it is exposed to direct sunlight, high heat or humidity, water may splash over it, or dust exists.

- When replacing a fuse, only use a new one with the prescribed rating. Using a fuse with the wrong rating may cause your unit to malfunction, on hot places such as above the dashboard.
- To prevent a short circuit when replacing a fuse, first disconnect the wiring harness.

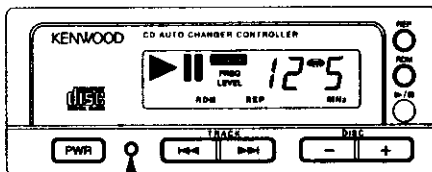

Reset button

NOTE

- If you have difficulty in installing this unit in your vehicle, contact your Kenwood dealer.
- If it doesn't seem to be working properly, first press the Reset button. If the malfunction persists, consult your Kenwood dealer.
- Some car stereos cause the sound of the tuner to make for a moment when an engine is activated.
- The reception of the tuner may be reduced a little if the KDC-C512FM, KDC-C462FM is used.
- If the sound is lower than the tuner sound, raise up the volume level of the CD with using the receiver.
- Do not use your own screws. Use only the screws provided. If you use the wrong screws, you could damage the unit.

Cleaning the Unit

If the front panel gets dirty, turn off the power and wipe the panel with a dry silicon cloth or soft cloth.

▲CAUTION

Do not use hard cloths or paint thinner, alcohol, or other volatile solvents. These may damage external surfaces or remove indicator characters.

Lens fogging

In cold climates, there may be a period after you turn on your vehicle's heater when the lens that guides the laser beam used in your CD player fogs up. If this happens, you cannot play compact discs. Take out discs and the fogging will disappear. If it does not return to normal after several hours, contact your Kenwood dealer.

Safety precautions

▲CAUTION

Do not set the remote on hot places such as above the dashboard.

Loading and Replacing the Batteries:

Use two "AAA" batteries.
Slide the cover while pressing downwards to remove it as illustrated.
Insert the batteries with the + and - poles aligned properly, following the illustration inside the case.

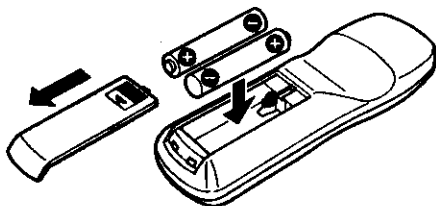

▲WARNING

Store unused batteries out of the reach of children. Contact a doctor immediately if the battery is accidentally swallowed.

NOTE

- The provided batteries are intended for use in operation checking, and their service life may be short.
- When the remote controllable distance becomes short, replace both of the batteries with new ones.

NOTE

A portion of the operations may not be possible, depending on the unit that is connected.

Handling Compact discs

Playing a CD that is dirty, scratched or warped can cause the sound to skip and the unit to operate incorrectly, resulting in worsened sound quality. Take the following precautions to prevent your CDs from getting scratched or damaged.

Handling CDs

- Do not touch the recorded side of the CD (the side opposite the label) when holding it.

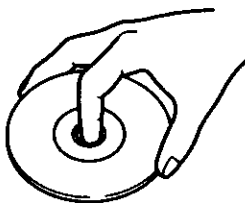

- Do not stick tape on either side of the CD.

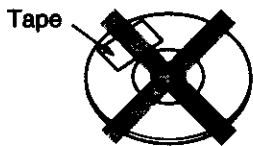

Storing CDs

- Do not store CDs in areas exposed to direct sunlight (such as a car seat or the dashboard) or other hot places.
- Remove CDs from the unit when not listening to them for a while, and put them back in their cases. Do not pile up CDs that are removed from their cases or prop them against something.

Cleaning CDs

If a CD has gotten dirty, wipe it off gently using a commercially available cleaning cloth or a soft cotton cloth, starting from the center of the disc and moving outward. Do not clean CDs with conventional record cleaners, anti-static formulas, or chemicals such as paint thinner or benzene.

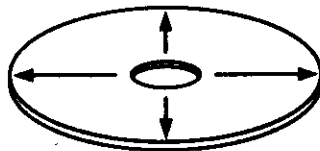

Checking New CDs for Burrs

When playing a new CD for the first time, check that there are not any burrs stuck to the perimeter of the disc or in the central hole. CDs with burrs stuck on them may not load properly or may skip while playing. Remove burrs using a ballpoint pen or a similar utensil.

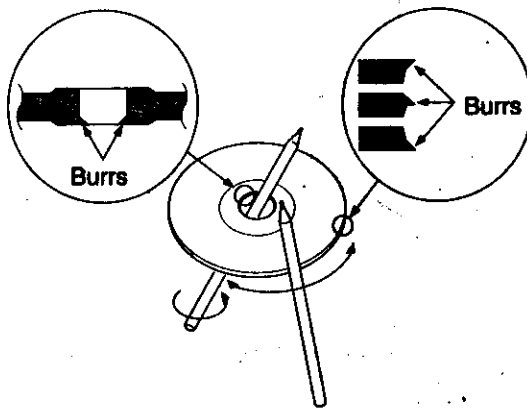

Do Not Load CD Accessories

Do not use commercially available CD accessories that can be loaded into the CD slot, such as stabilizers, protective sheets, or CD cleaning discs, since they can cause the unit to malfunction.

CAUTION

Do Not Use Special Shape CDs

- Be sure to use round shape CDs only for this unit and do not use any special shape CDs. Use of special shape CDs may cause the unit to malfunction.



- Be sure to use CDs with disc mark  only for this unit.

Loading compact discs

English

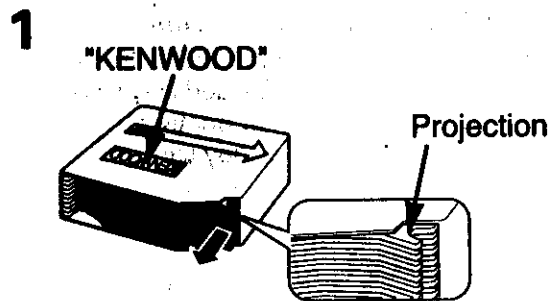

Make sure the disc magazine is the right way up with the Kenwood logo on the top. Pull the tray out by the projection.

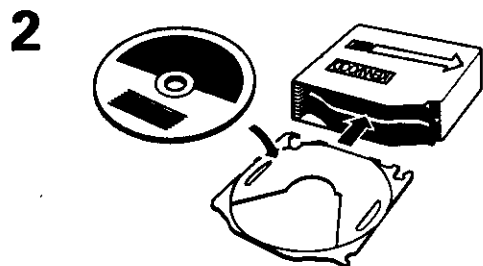

Place the disc on the tray with the label facing upwards. Insert the tray into the disc magazine until it locks. The discs are numbered from the bottom from 1 to 6 or 10.

CAUTION

- Take care to insert the tray into the correct grooves in the disc magazine.
- 8-cm discs cannot be used. If an 8-cm disc adapter is used, the disc cannot be ejected.
- Keep all the trays in the magazine even when empty.

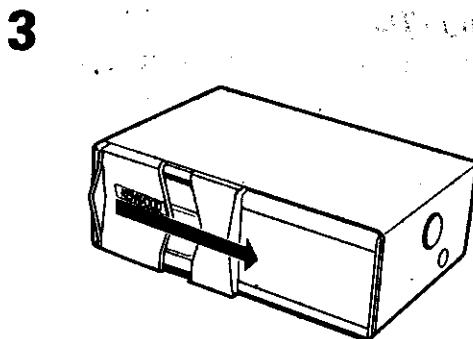

Open the CD changer door.

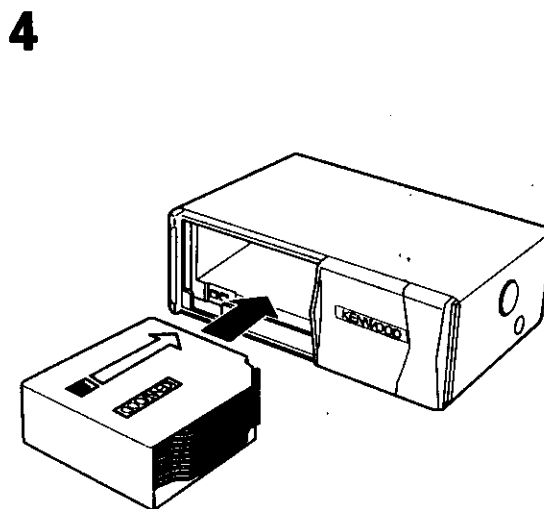

Insert the magazine into the CD changer until it clicks.

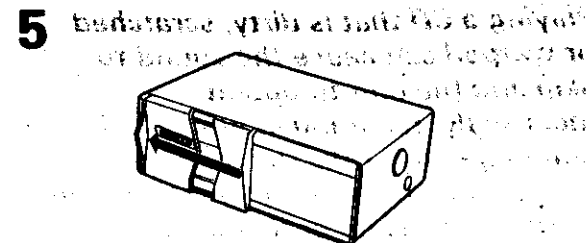

Close the CD changer door.

NOTE

Use the CD changer with its door closed to prevent the entry of dust into the changer.

6 Magazine ejection

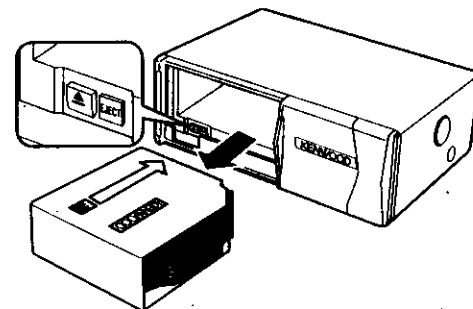

Open the CD changer door, and press the "EJECT" button.

NOTE

Be sure to open the door completely before pressing the EJECT button. If the door is not completely open, the magazine may hit the door and cause damage or malfunction.

Buttons

Display Unit

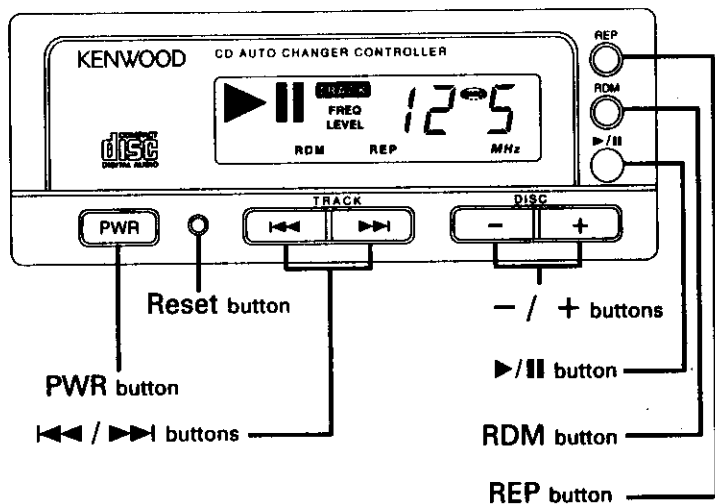

Remote

(Supplied with the KDC-C512FM)

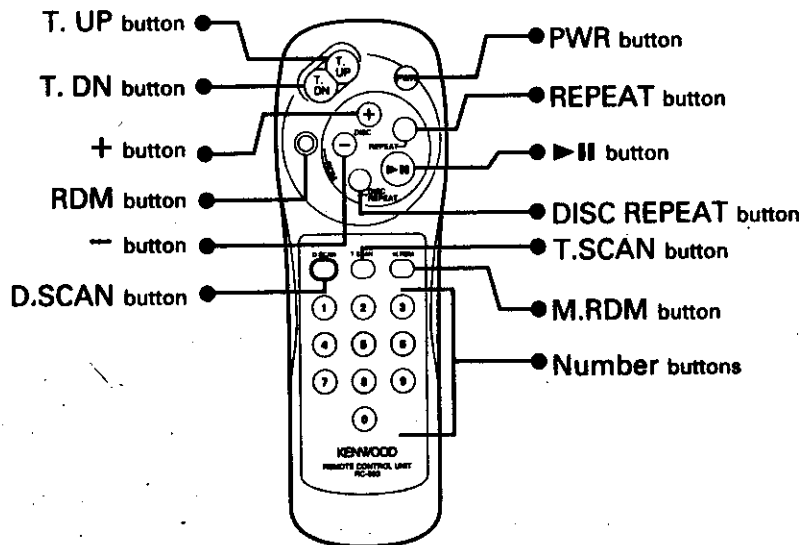

External disc control features

Set the car radio FM station to 88.3 MHz. See Page 13 for more information on changing the transmission frequency.

Playing CDs

Playing CDs:

Press the PWR button.

The power goes ON and the CD play start. When the unit receives any signal from the remote controller, the  mark lights up.

Play indicator

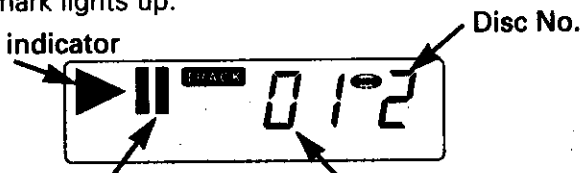

Pause indicator

Track No.

When the player reaches the end of the last track on the disc you are playing, it will shift automatically to the first track on the next disc. When the player plays the last disc, it will return to the first disc.

The play display blinks during disc replacement.

Disc No. 10 is displayed as "0". (KDC-C512FM only)

Power off :

Press the PWR button.

The power goes OFF.

To listen to the radio :

Press the PWR button.

The FM modulator is turned OFF and the radio can be heard.

Pause :

Press the  (▶||▶...Remote) button.

Disc play is temporarily paused.

If you press the switch once more, the disc is replayed from the paused part.

NOTE

- Be sure to turn down the volume whenever you listen to the radio or a cassette tape after stopping the disc play.
- During the disc play is being conducted, you are not able to receive ordinary Radio broadcasting because antenna output is switched into compact disc player's side.

External disc control features

Fast Forwarding and Reversing Disc Play

Fast Forwarding Disc Play :

Hold down on the ►► button.

Release your finger to play the disc at that point.

Reversing Disc Play :

Hold down on the ◀◀ button.

Release your finger to play the disc at the point.

Track Search

Search forward or backward through the tracks on the disc until you reach the one that you want to listen to.

Making a Reverse Track Search :

Press the ◀◀ (T. DN...Remote) button to display the desired track number.

Press once to search back to the beginning of the current track, twice to search back to the beginning of the previous track, and so forth.

Play starts at the beginning of the displayed track number.

NOTE

Pressing the ◀◀ (T. DN...Remote) button while listening to track 1 will only search back to the beginning of that track. The reverse search is not "recycled" to the last track on the disc.

Making a Forward Track Search:

Press the ►► (T. UP...Remote) button to display the desired track number.

Press once to fast forward to the next track, twice to fast forward to the track after that, and so forth.

Play starts at the beginning of the displayed track number.

NOTE

You cannot make a forward track search when listening to the last track on a disc.

Disc Search

Search forward or backward through the discs in a disc changer.

Making a Reverse Disc Search :

Press the - button to display the desired disc number.

Each time the button is pressed, the displayed disc number decreases by one.

Play starts at the beginning of the displayed disc.

Making a Forward Disc Search :

Press the + button to display the desired disc number.

Each time the button is pressed, the displayed disc number increases by one.

Play starts at the beginning of the displayed disc.

Direct Track Search

Function of Remote

Using the remote, directly input the track number that you want to listen to.

- Using the number buttons on the remote, input the number of the track that you want to listen to.
The selected track number will blink in the display for 10 seconds.
If you make no further input in the 10-second period, the number entry mode will automatically be canceled.
- Press either the T. DN or T. UP button while the track number is blinking.
The track starts playing.

Canceling Direct Track Search While It Is Operating :

Press the ►|| button.

Direct Disc Search

Function of remote

Using the remote, directly input the disc number that you want to listen to.

- 1 Using the number buttons on the remote, input the number of the disc that you want to listen to.
The selected disc number will blink in the display for 10 seconds.
If you make no further input in the 10-second period, the number entry mode will automatically be canceled.

NOTE

- Input "0" to select disc 10.
 - If you input more than two numbers all at once, a search will be made only of the last number input.
- 2 Press either the + or - button while the number inputted is blinking.
The disc starts playing.

Canceling Direct Disc Search While It Is Operating :

Press the ►|| button.

Track Repeat

Repeat playing the track currently being listened to.

To repeat track :

Press the REP (REPEAT...Remote) button.
The REP indicator will appear on the display and the Track repeat function will turn on.
The same track is played repeatedly.

To cancel :

Press the REP (REPEAT...Remote) button.
The REP indicator disappears and the Track repeat function is canceled.

NOTE

When disc play stops, Track repeat is canceled.

Disc Repeat

Function of remote

Repeat playing the disc currently being listened to.

To repeat disc :

Press the DISC REPEAT button.
The D.REP indicator will appear on the display and the Disc repeat function will turn on.
The same disc is played repeatedly.

To cancel :

Press the DISC REPEAT button.
The D.REP indicator disappears and the Disc repeat function is canceled.

NOTE

When disc play stops, Disc repeat is canceled.



Track Scan

Function of remote

Successively play the beginning of each track on a disc until you find the track that you want to listen to.

Starting the Track Scan:

Press the T.SCAN button. The SCN indicator will appear on the display and the player will play the first 10 seconds of each track in succession.

Stopping to Listen to the Track Being Scanned :

Press the ►|| or T.SCAN button.
The SCN indicator disappears and the Track scan is canceled.
Normal playback starts.

NOTE

- When disc play stops, Track scan is canceled.
- When all tracks on the disc you are listening to are scanned, Track scan is canceled.

External disc control features

Disc Scan

Function of remote

Successively play the beginning of each disc on a changer until you find the one that you want to listen to.

Starting the disc scan:

Press the D.SCAN button. The D.SCN indicator lights up and the first 10 seconds of each disc are played, in the order in which they are loaded on the changer.

The disc number currently being heard blinks in the display.

Stopping to Listen to the Disc Being Scanned :

Press the ►|| or D.SCAN button again to stop the scan and keep on listening to the disc normally.

NOTE

- The disc scan function is cancelled when you stop playing a disc.
- When all discs in the magazine you are listening to are scanned, Disc scan is cancelled.

Random Play

Play all the tracks on the current disc in random order.

- 1 Press the RDM button to switch the random play function on and off.
The RDM indicator lights up when the random play function is turned on.
The display of the track number changes continuously as the next track is being selected.
When the track has been selected, play starts.
The selected track number blinks in the display as it is being played.

NOTE

When all the tracks on a certain disc have been played using the random play function, the next disc on the changer starts playing (with the random play function still turned on).

- 2 To change the track being heard, press the ►► (T. UP...Remote) button.
Another track is selected and played.

NOTE

The random play function is cancelled when you stop playing a disc.

Magazine Random Play

Function of remote

Play the tracks on all the discs in the disc changer in random order.

- 1 Press the M.RDM button to switch magazine random play on and off.
The M.RDM indicator lights up when magazine random play is turned on.
The disc and track numbers will change over and over in the display as the next track is being selected.
When the disc/track has been selected, play will begin.
The selected disc/ track number blinks in the display as it is being played.
- 2 To change the track being heard, press the T. UP button.
Another disc/track will be selected and played.

NOTE

- Magazine random play is canceled when you stop playing a disc.
- The time needed for random selection depends on the number of discs loaded in the disc magazine.

Changing the transmission frequency

1 To set the frequency change mode

Press the REP button for at least three seconds. The FREQ indicator will light up and the currently set frequency will be displayed.



NOTE

- The initial value is 88.3MHz.
- If this function is on, the functions other than power on / off, reset, and modulation level / dynamic control, cannot be operated.
- This function is not available when the random play, repeat play, or scan play function is on. Before using this function, cancel the other functions. This function cannot be used while loading a disc (while the play indicator is blinking).

2 To change the frequency

Press either the ◀◀ or ▶▶ button.

Each time you press the ◀◀ or ▶▶ button, the mode switches as follows :

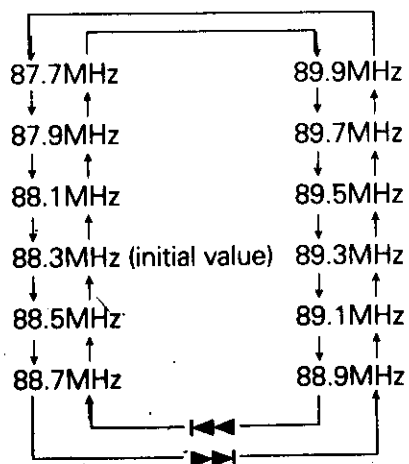

NOTE

Some car radios cannot receive a 87.7 MHz frequency.

To cancel :

Press the REP button on the display unit for at least three seconds.

The FREQ indicator will go off and the frequency change will take effect.

The frequency change mode is automatically canceled if you do nothing for 15 seconds.

External disc control features

Modulation level / Dynamic control

1 To set the control mode

Press the RDM button on the display unit for at least three seconds.

The LEVEL indicator will light up and the currently set modulation level will be displayed.

Modulation level



Number for prevention of distortion setting

NOTE

- If this function is on, the functions other than power on / off, reset, and changing the transmission frequency, cannot be operated.
- This function is not available when the random play, repeat play, or scan play function is on. Before using this function, cancel the other functions. This function cannot be used while loading a disc (while the play indicator is blinking).

2 To change the modulation level

Press either the ◀◀ or ▶▶ button.

Each time the ◀◀ or ▶▶ button is pressed, the modulation level changes in the range from 1 to 4. As the number increases, the modulation level increases. The initial setting is 2.

NOTE Dynamic control

The unit comes with the prevention of distortion function to reduce sound distortion.

If the sound is distorted severely, press the + button on the display unit and then set the function to "2" (ON). If the prevention of distortion function is set to "2" (ON), the sound extension is reduced.

The initial setting is "1" (OFF).

CAUTION

If a disc with a high recording level is used, the sound may distort even if the prevention of distortion function is set to "2" (ON). In this case, reduce the modulation level.





To cancel :

Press the RDM button on the display unit for at least three seconds.

The LEVEL indicator will go off and the modulation level change will take effect. The control mode is automatically canceled if you do nothing for 15 seconds.

Accessories

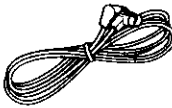
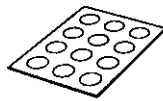
External view

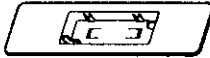
	Number of items		
①	1	②	4
③	4	④	1
⑤	1	⑥	1
⑦	2	⑧	1

▲CAUTION

The use of any accessories except for those provided might result in damage to the unit. Make sure only to use the accessories shipped with the unit, as shown above.

Installation Procedure

1. To prevent a short circuit, remove the key from the ignition and disconnect the ⊖ battery.
2. Make the proper input and output wire connections for each unit.
3. Connect the wiring harness wires in the following order: ground, battery, ignition.
4. Install the unit in your car.
5. Reconnect the ⊖ battery.
6. Press the reset button.

▲WARNING

When drilling a hole in the car chassis to install the unit, check first that nothing is on the other side.

▲CAUTION

- If the fuse blows, first make sure the wires aren't touching to cause a short circuit, then replace the old fuse with one with the same rating.
- Do not let unconnected wires or terminals touch metal on the car or anything else conducting electricity. To prevent a short circuit, do not remove the caps on the ends of the unconnected wires or the terminals.
- After the unit is installed, check whether the brake lamps, blinkers, wipers, etc. on the car are working properly.
- Insulate unconnected wires with vinyl tape or other similar material.
- Some disc changers need conversion cords for connection. See the section on "Safety Precautions" for details.

■ Removing the transportation screws

Remove all 3 transportation screws for protecting the internal mechanism before you start to install the unit.

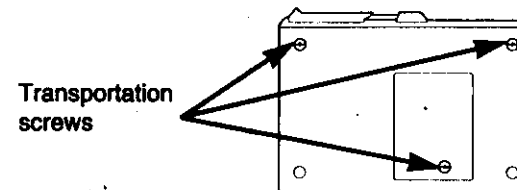

NOTE

After removing the transport screw, retain it carefully and attach it again before transporting the unit again.

Installation Procedure

■ Angle adjustment switches

The angle adjustment switches on the both sides of the unit are to be set according to the angle of installation of the CD auto changer. Set both of the two switches to the same position. If the switches are not set properly, sound skip or other malfunction may occur.

Set the angle adjustment switches with a coin or other flat object.

Change the switch step by step by detaching and reusing the object at the end of each step.

Angle adjustment switches



	0°~5°	40°~50°	85°~90°
Installation angle			
Angle adjustment switch position			

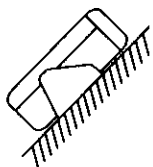

• It is not possible to install at an angle of 40°~50° if only ① is used.

Connecting Wires to Terminals

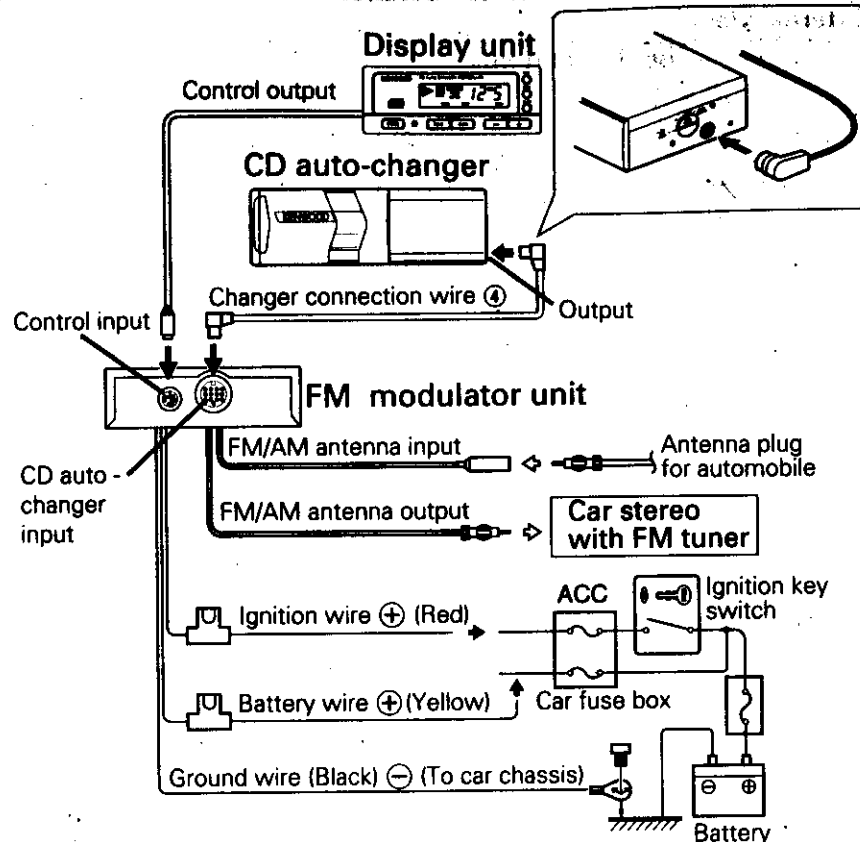

▲WARNING

To prevent fire when the ignition wire (Red) or battery wire (Yellow) is short-circuited by coming into contact with the vehicle chassis (ground), only connect the power supply after making the fuse box connections.

▲CAUTION

Be sure to press the reset button after installation.

NOTE

Do not install an antenna of radio equipment or distribute the antenna wire near the changer output wire, for this could cause malfunction with this unit.

Installation

■ Horizontal installation

Cover the holes indicated by (▶) with the dustproof seals ⑤.
(Bottom and sides)
Use the holes marked (●) to install the unit.

Bottom view

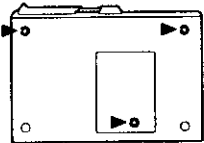

Side view KDC-C512FM

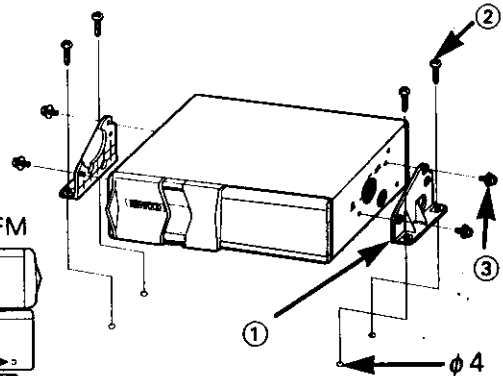
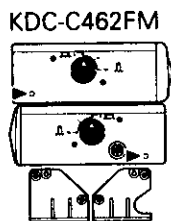
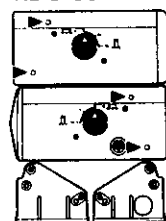

■ In case of hanging in the trunk

Cover the holes indicated by (▶) with the dustproof seals ⑤.
(Bottom and sides)
Use the holes marked (●) to install the unit.

Bottom view

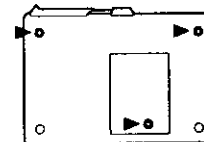

Side view KDC-C512FM

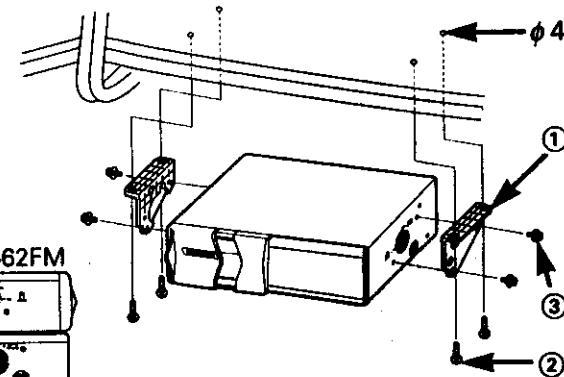
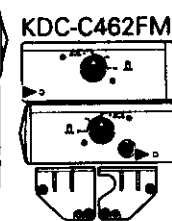
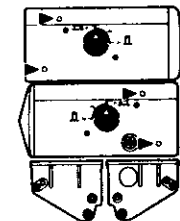

■ Vertical installation

Cover the holes indicated by (▶) with the dustproof seals ⑤.
(Bottom and sides)
Use the holes marked (●) to install the unit.

Bottom view

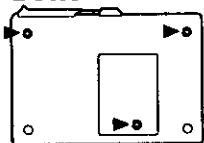

Side view KDC-C512FM

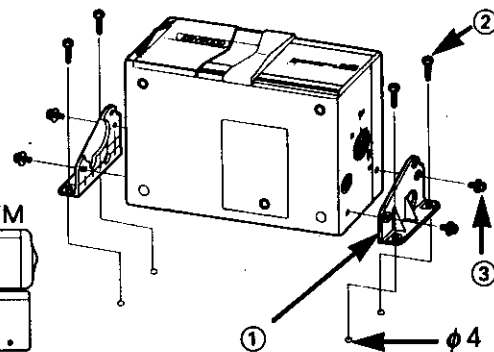
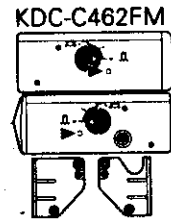
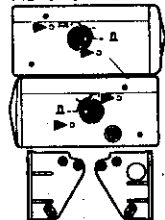

■ Installation of FM modulator unit

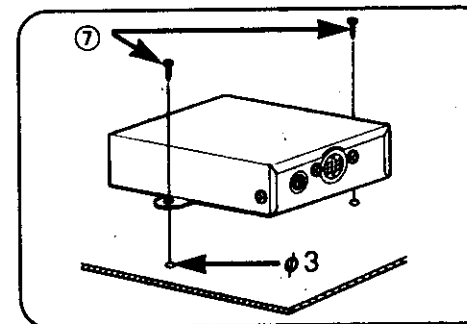

⚠ CAUTION

Take sufficient care so that the wires are not caught under the seat. If they are caught, they may break.

Install the FM modulator unit beneath the front seat using Metal fixture and Bind head screw as shown in the above figure.

■ Installation of Display unit

- Installation without using the trim mount plate ⑧

Display unit

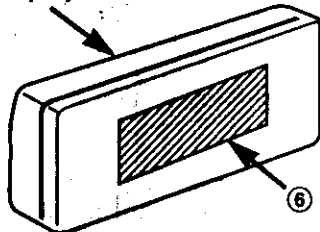

Attach one velcro to the slanted-line of the the display units as shown above, and attach the other velcro to the parts where you wish to attach the display units. Then, put velcros together and install the display units.

- Installation using the trim mount plate ⑧

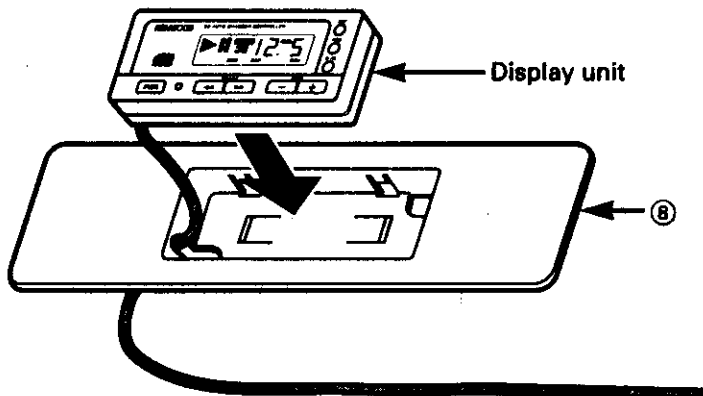

Pass the wire from the display unit through the hole on the trim mount plate and push fit the display unit into the trim mount plate until it locks.

▲CAUTION

- Be sure not to place the unit on such place as where it is exposed to direct sunlight and temperature eventually rises. It results in the deformation of the case.
- Depending on the installing location, the display unit may not be able to receive the signals from the controller unit. Install them after confirming that the signals can be received.
- Install the unit in such a way that it does not disturb driving.

Troubleshooting Guide

What might seem to be a malfunction in your unit may just be the result of slight misoperation or miswiring. Before calling service, first check the following table for possible problems.

PROBLEM	POSSIBLE CAUSE	SOLUTION
The power is not turned on.	The wiring harness fuse blows	Check wires for shorts, then replace the fuse with one of with the same rating (shown on the case).
No sound or sound is low.	The volume level is minimum.	Raise the volume level.
	The fader or balance is set to one side	Adjust the fader and balance.
	The input/output wire or wiring harness is connected incorrectly.	Connect the input/output wire or wiring harness correctly. See "Connecting Wires to Terminals" (Page 16).
The unit does not work properly when a button is pressed.	The microcomputer malfunctions.	Press the Reset button of the display unit.
Sound quality is poor. (Sound distortion)	The volume level is too high.	Use the appropriate volume level.
CD play does not start.	CD auto-changer input is not connected to the unit.	Connect the CD auto-changer input to the unit.
	Power button is not turned ON.	Turn the power button ON.
The specified disc is not played; a different disc is played instead.	The specified disc is very dirty.	Check and, if possible, clean the disc. See "Cleaning CDs" (Page 7).
	The disc is loaded upside down.	Eject the disc magazine and insert the disc correctly.
	Two discs are inserted in a slot.	Eject the disc magazine and insert the discs correctly.
	The number of the slot into which the disc is inserted is different from the number of the specified disc.	Eject the disc magazine and check the number of the specified disc.
	The disc is severely damaged.	Use another disc.

PROBLEM	POSSIBLE CAUSE	SOLUTION
Sound skips due to vibration.	Something is touching the CD auto-changer.	Keep it away from the CD auto-changer.
	The disc is dirty or damaged.	If sound skips at the same part, the disc is faulty. Check and, if possible, clean the disc. See "Cleaning CDs" (Page 7).
	The unit is mounted at a slant.	Mount the unit so that is level.
	Changer unit is mounted in an unstable place.	Mount the unit in a stable place.
Nothing appears on the display.	The angle adjustment switches are set improperly.	Set the angle adjustment switches to the correct positions.
	The control output of the display unit is not connected properly.	Connect the control output properly.
Sound distortion.	A disc with a high recording level is used.	Change the modulation level / dynamic control setting.(Page 14)
Sound quality is poor.	The recording of the disc is poor.	Try playing another disc. If the sound is good, the fault was with the original disc.
	The disc is dirty or damaged.	Check and, if possible, clean the disc. See "Cleaning CDs" . (Page 7)"
No sound is heard even though the information concerning the CD auto-changer is displayed.	Volume is set to minimum level.	Raise the volume level.
	The microcomputer does not function correctly.	Press the Reset button of the display unit.
	The system is not connected properly.	Connect the system properly. See "Connecting Wires to Terminals" .(Page 16)
The specified track is not played.	The player is set to Random Play / Magazine Random Play.	Turn off Random Play / Magazine Random Play.

The following messages are displayed when certain problems are occurring in your system. Take the recommended actions.

- 01 E:** No disc magazine has been loaded in the changer. The disc magazine is not completely loaded.
⇒ Load the disc magazine properly.
- 02 E:** No disc has been loaded in the disc magazine..
⇒ Load a disc into the disc magazine.
- 04 E:** No disc has been loaded in the disc magazine.
⇒ Load a disc into the disc magazine
The CD is quite dirty. The CD is upside-down. The CD is scratched a lot.
⇒ Clean the CD and load it correctly.
- 77 E:** The unit is malfunctioning for some reason.
⇒ Press the reset button on the unit. If the "77E" code does not disappear, consult your nearest service center.
- 99 E:** Something is wrong with the disc magazine. Or the unit is malfunctioning for some reason.
⇒ Check the disc magazine. And then, press the reset button on the unit.
If the "99E" code does not disappear, consult your nearest service center.
- 0d E:** The protective circuit in the unit activates when the temperature inside the automatic disc changer exceeds 60°C (140°F), stopping all operation.
⇒ Cool down the unit by opening the windows or turning on the air conditioner. As the temperature falls below 60°C (140°F), the disc will start playing again.

Specifications

Specifications subject to change without notice.

Disc section

Laser Diode.....	GaAlAs ($\lambda=780$ nm)
Digital Filter (D/A).....	8 Times Over Sampling
D/A Converter.....	1 bit
Spindle speed.....	500 ~ 200 rpm (CLV)
Wow & Flutter.....	Below Measurable Limit
Frequency Response (± 1 dB).....	10 Hz ~ 20 kHz
Modulating Frequency (200KHz STEP).....	87.7, 87.9, 88.1, 88.3, 88.5, 88.7, 88.9, 89.1, 89.3, 89.5, 89.7, 89.9 MHz

General

Operating Voltage.....	14.4 V (11 ~ 16 V)
Current consumption.....	1.4 A
Operating Temperature.....	-10 ~ 50 °C

Size (W x H x D)

CD changer.....	250 x 80 x 176 mm (9-13/16 x 3-1/8 x 6-15/16 in.)
Controller.....	50 x 145 x 24 mm (1-15/16 x 5-11/16 x 15/16 in.)
Display unit.....	105 x 40 x 18 mm (4-1/8 x 1-9/16 x 11/16 in.)
FM modulator unit.....	150 x 30 x 80 mm (5-7/8 x 1-3/16 x 3-1/8 in.)
Trim mount plate.....	188 x 58 x 2 mm (7-3/8 x 2-5/16 x 1/16 in.)

Weight

CD changer.....	2.0 kg (4.4 lbs)
Controller.....	0.060 kg (0.14 lbs)
Display unit.....	0.125 kg (0.28 lbs)
FM modulator unit.....	0.600 kg (1.3 lbs)